

HIGH CURRENT INDUCTORS

MODEL NO : SSC-27014 HF & SSC-27017 HF & SSC-27019 HF SERIES

FEATURES:

- * LOW CORE LOSS AND HIGH EFFICIENCY PERFORMANCE.
- * CLOSED MAGNETIC FIELD CONSTRUCTION FOR HIGH DENSITY BOARD ASSEMBLY
- * COMPLIANT WITH RoHS AND HALOGEN FREE.

APPLICATION:

- DC/DC CONVERTER IN POWER REGULATION SYSTEM.
- PV INVERTERS.

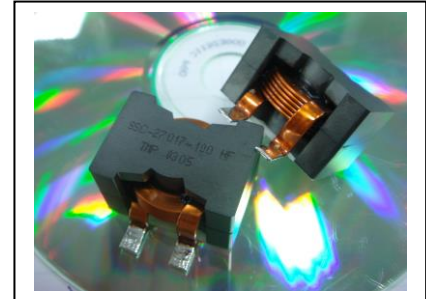

ELECTRICAL SPECIFICATION:

MODEL NO	INDUCTANCE ±10% (uH)	DCR ±10% (mΩ)	TEMPERATURE RISE CURRENT (ADC)	SATURATION CURRENT (ADC) (NOTE 3)	TOTAL HEIGHT MAX (mm)
SSC-27014-1R5L HF	1.5	1.50	30	> 100	14.22
SSC-27014-2R2 HF	2.2	1.83	30	> 100	14.22
SSC-27014-2R2L HF	2.2	1.50	30	84.8	14.22
SSC-27014-3R3 HF	3.3	1.83	30	68.4	14.22
SSC-27014-3R3L HF	3.3	1.50	30	57.0	14.22
SSC-27014-4R7 HF	4.7	1.83	30	50.1	14.22
SSC-27014-4R7L HF	4.7	1.50	30	39.0	14.22
SSC-27014-6R8 HF	6.8	1.83	30	36.2	14.22
SSC-27014-6R8L HF	6.8	1.50	30	27.8	14.22
SSC-27014-100 HF	10	1.83	30	23.4	14.22
SSC-27014-100L HF	10	1.50	30	17.6	14.22
SSC-27014-150 HF	15	1.83	30	15.2	14.22
SSC-27014-150L HF	15	1.50	30	11.0	14.22
SSC-27014-220 HF	22	1.83	30	9.6	14.22
SSC-27014-220L HF	22	1.50	30	6.8	14.22
SSC-27014-330 HF	33	1.83	30	5.9	14.22
SSC-27014-330L HF	33	1.50	30	3.3	14.22
SSC-27017-3R3 HF	3.3	2.45	28	93.6	17.0
SSC-27017-4R7 HF	4.7	2.45	28	62.4	17.0
SSC-27017-6R8 HF	6.8	2.45	28	45.9	17.0
SSC-27017-100 HF	10	2.45	28	32.1	17.0
SSC-27017-150 HF	15	2.45	28	21.5	17.0
SSC-27017-220 HF	22	2.45	28	14.5	17.0
SSC-27017-330 HF	33	2.45	28	9.3	17.0
SSC-27017-350 HF	35	9.0 MAX	16	18.5	17.5
SSC-27017-500 HF	50	10.5	15	15.0	18.0
SSC-27019-100 HF	10	3.45	28	41.0	18.8

NOTE (1): Test frequency: 500 KHZ ,0.1Vrms.

NOTE (2): $\Delta T=40^{\circ}\text{C}$ approximately under the temperature rise current.

NOTE (3): The saturation current indicates the value of DC current is approximately 30% lower than its initial value of inductance.

NOTE (4): Operating temperature range: $-40^{\circ}\text{C} \sim +125^{\circ}\text{C}$

NOTE (5): Weight : SSC-27014 Series : 31.0 g / pcs.

SSC-27014-xxxL Series: 29.5 g / pcs.

SSC-27017 Series : 34.0 g / pcs.

SSC-27019 Series : 41.0 g / pcs

PHYSICAL DIMENSION : (UNIT:mm)

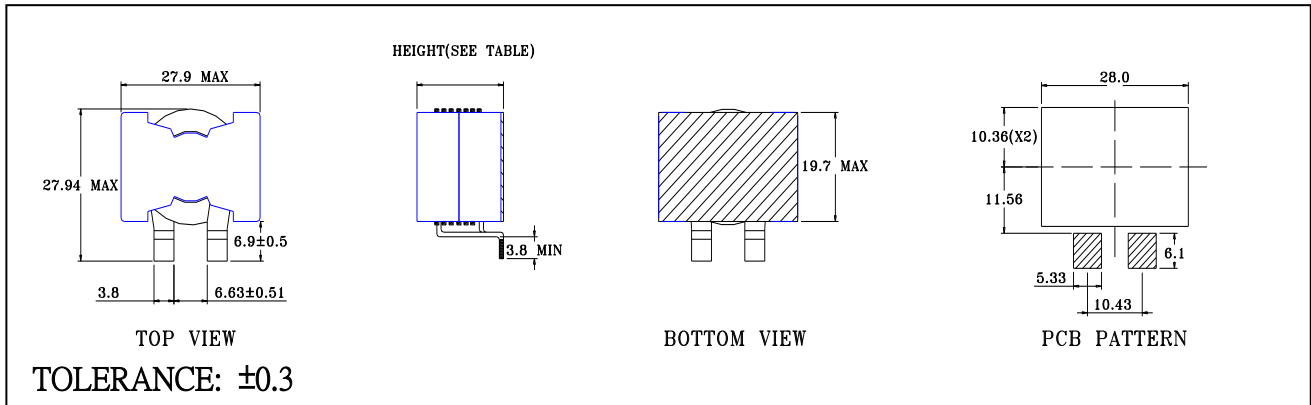

INDUCTANCE VS DC BIAS:

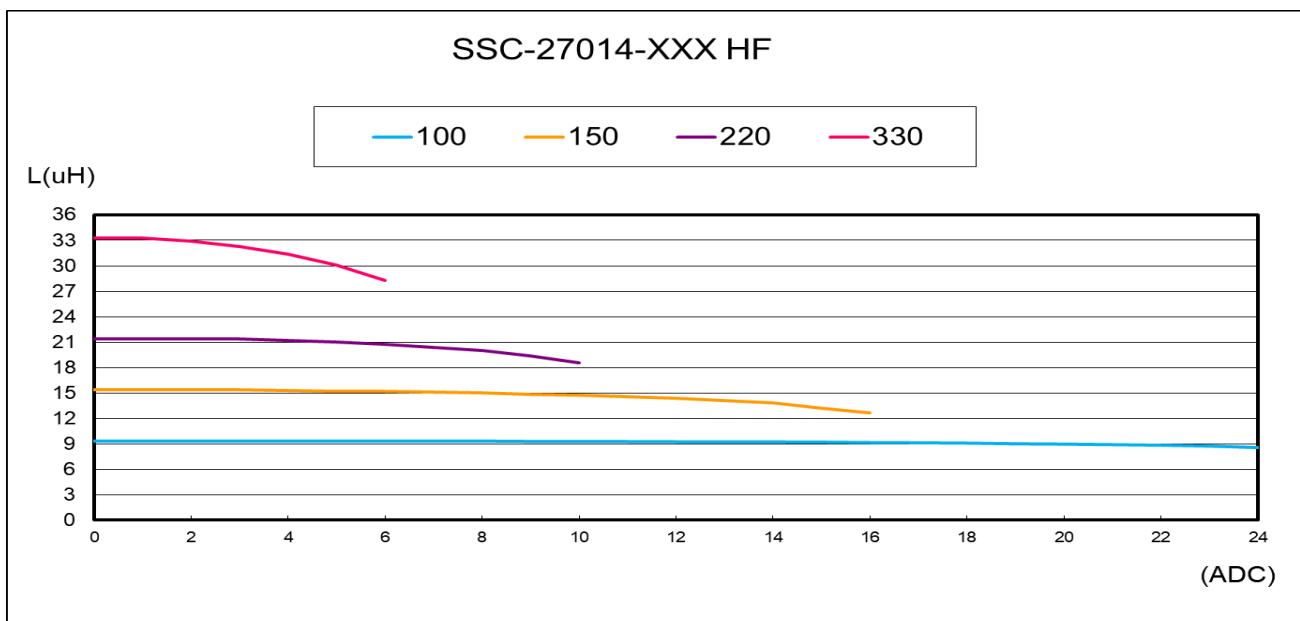
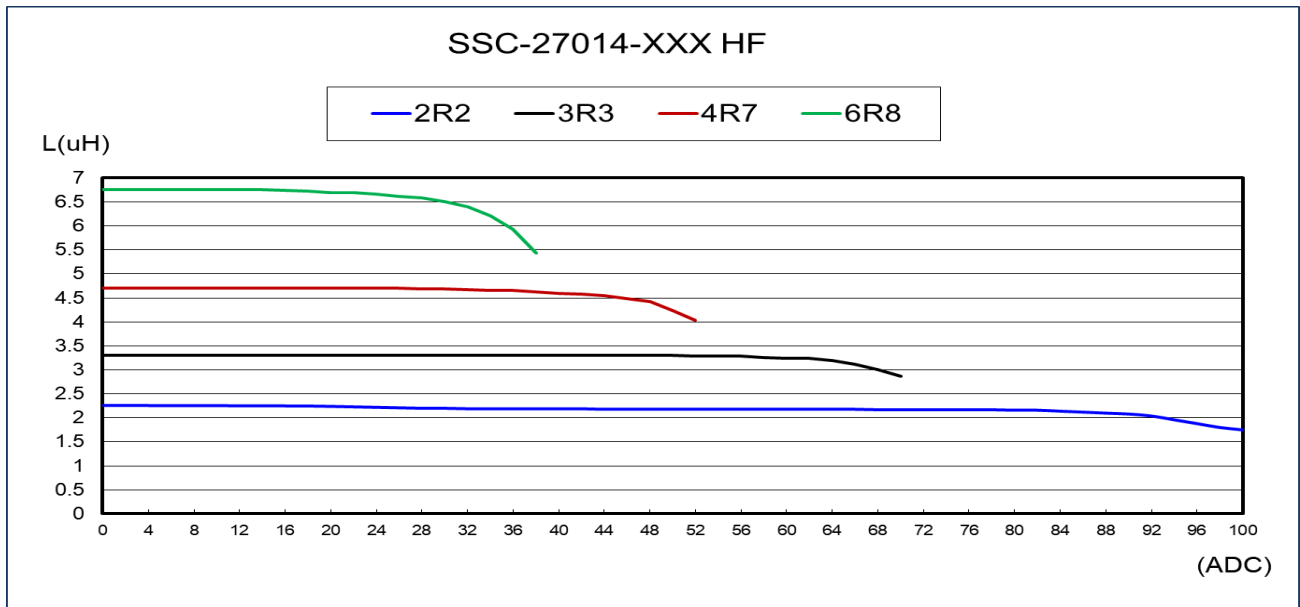

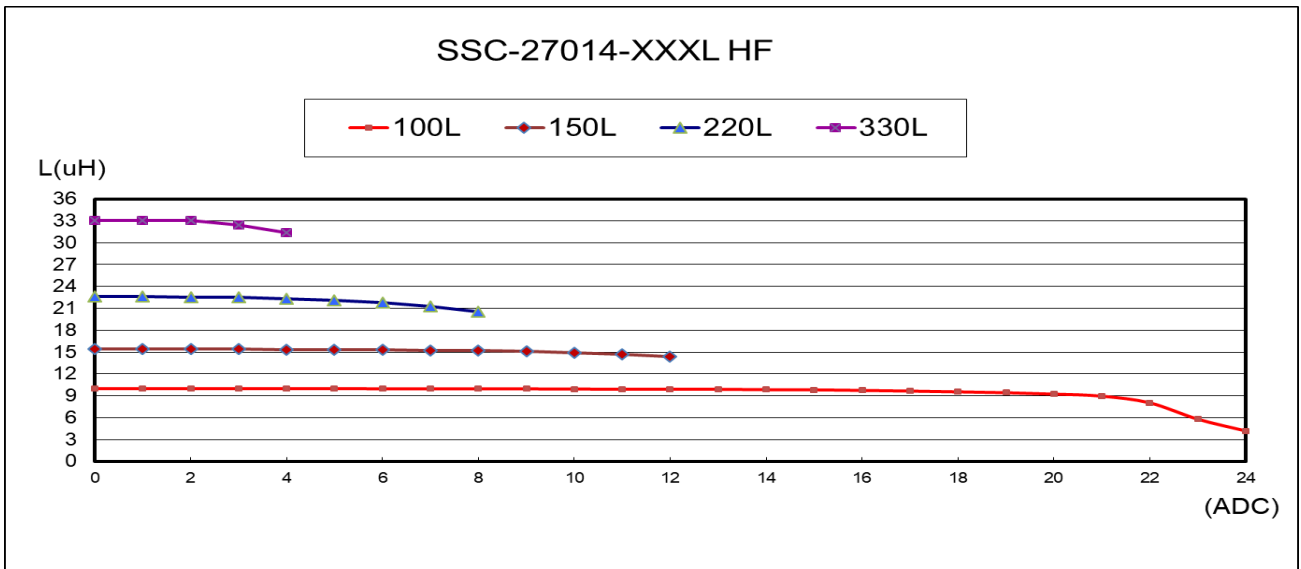
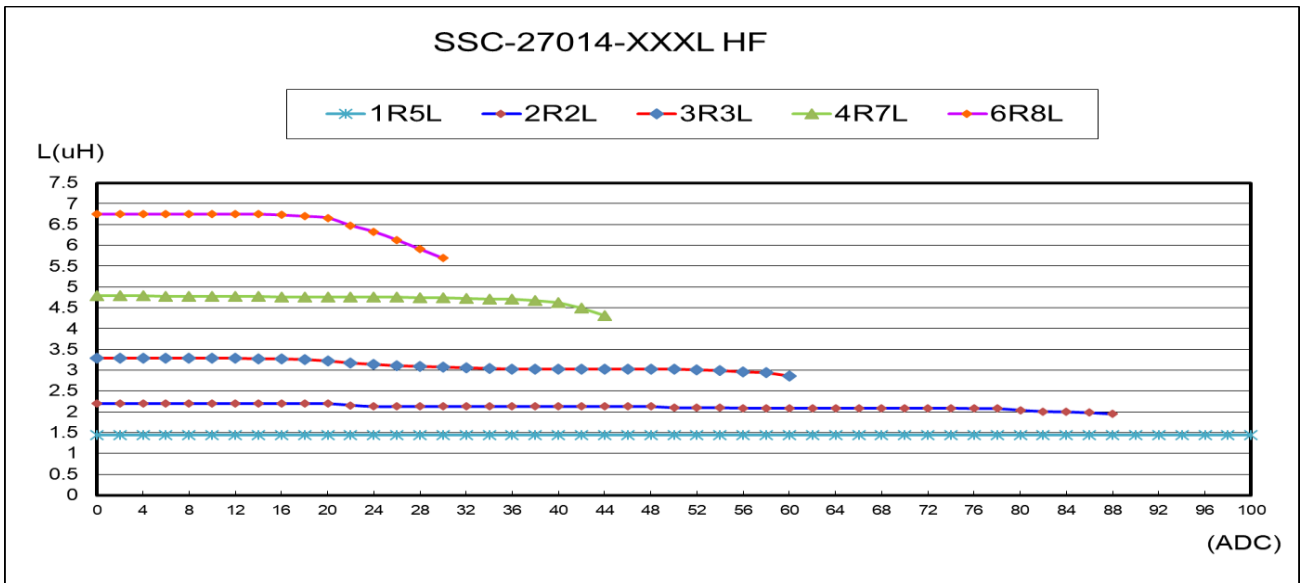

TEMPERATURE RISE VS DC BIAS:

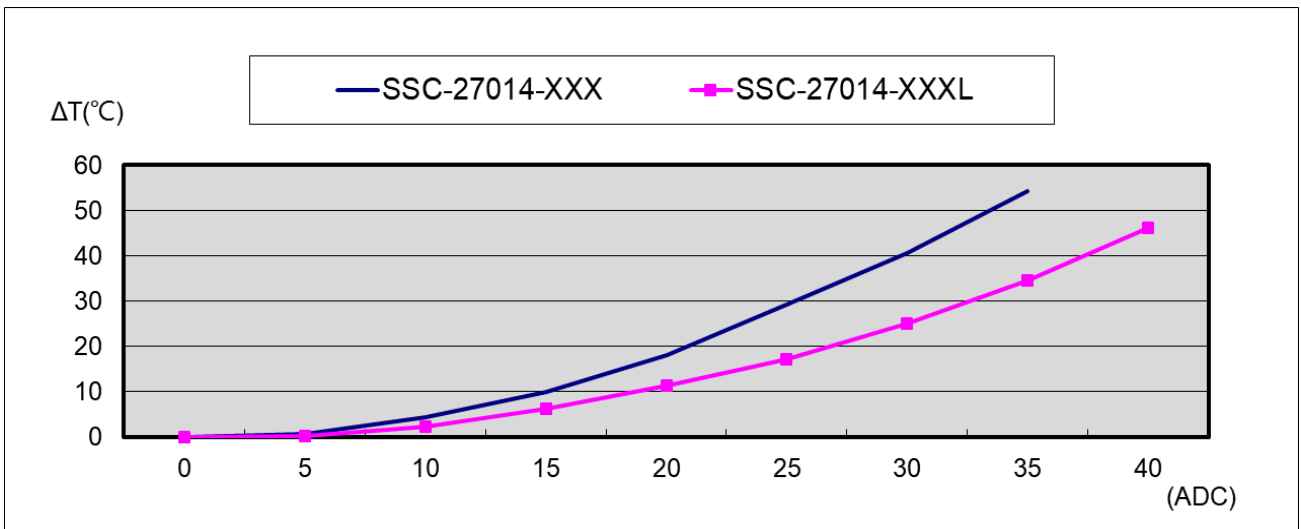

INDUCTANCE VS DC BIAS:

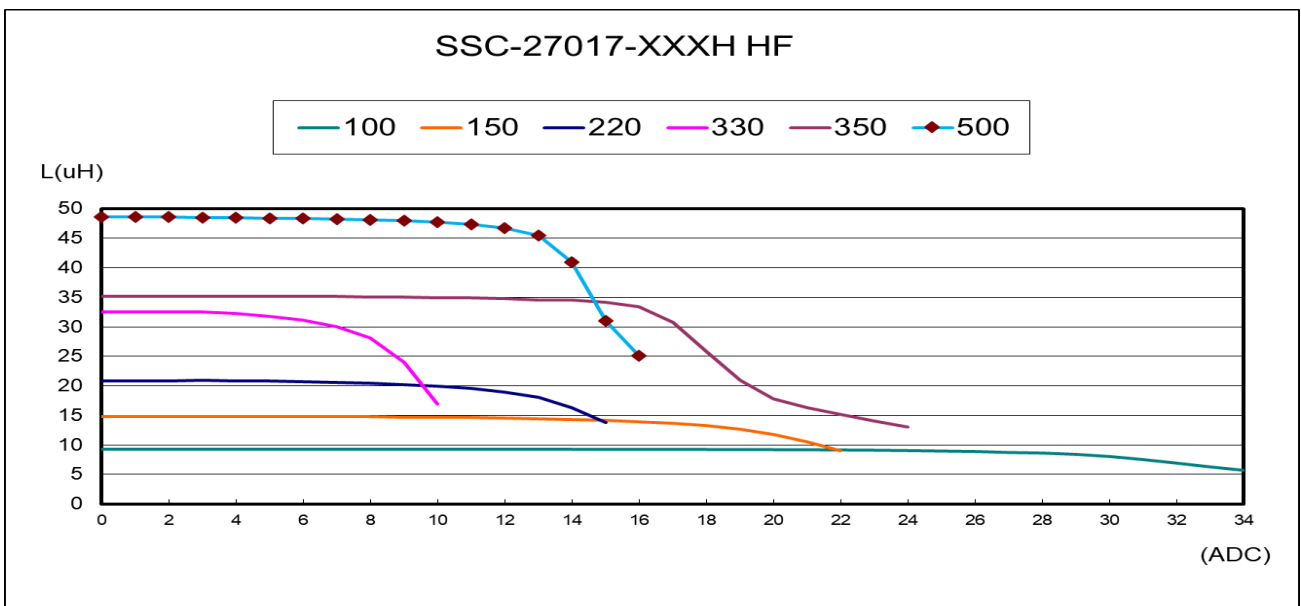
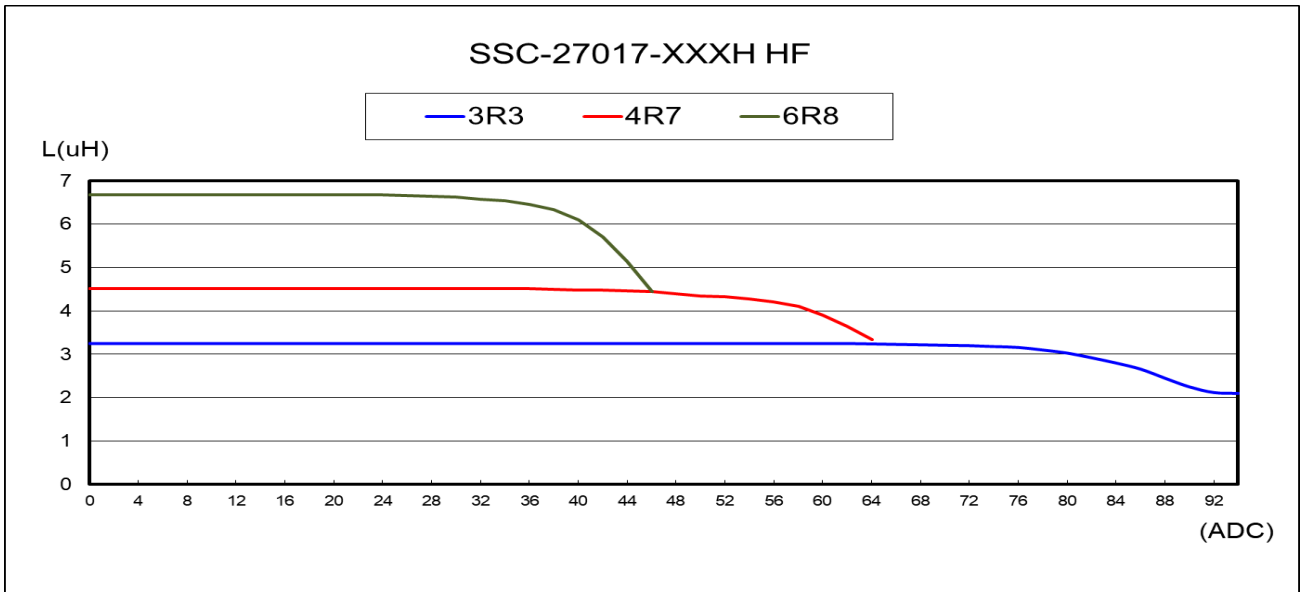

TEMPERATURE RISE VS DC BIAS:

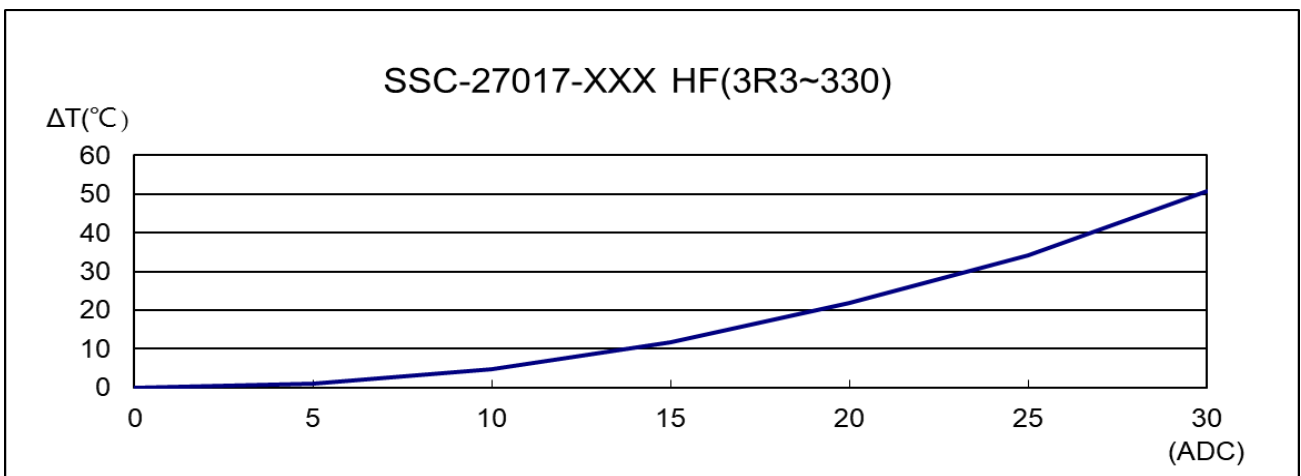

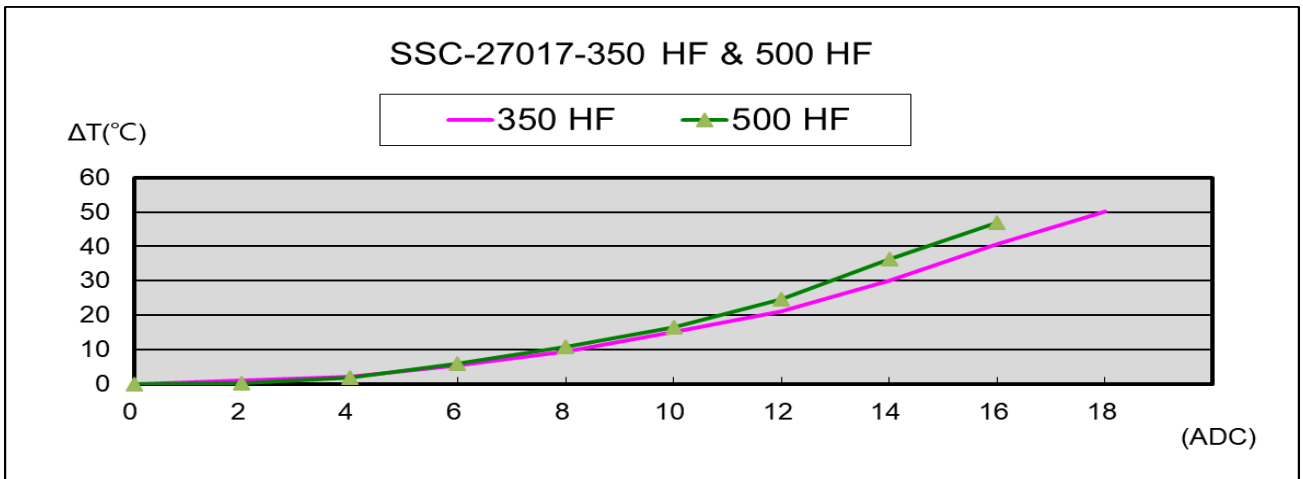

INDUCTANCE VS DC BIAS:

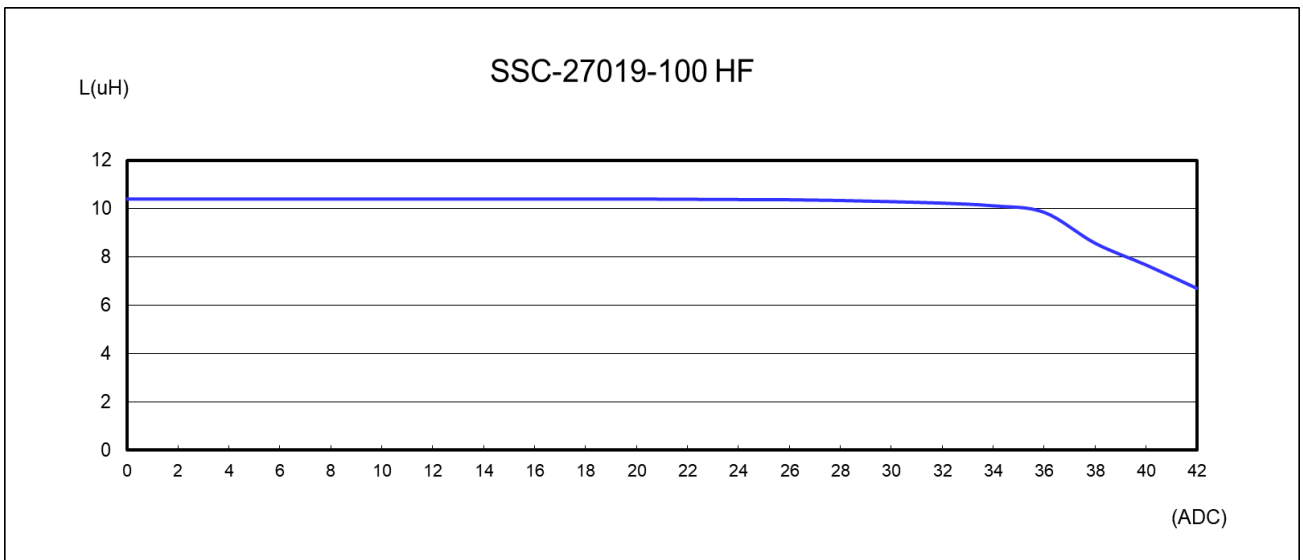

TEMPERATURE RISE VS DC BIAS:

